

T-MODE



TM

XT6 433

XT6S 433

FAAC

		<p>TASTO DI PROGRAMMAZIONE - PROGRAMMING SWITCH - TOUCHE DE PROGRAMMATION - PROGRAMMIERTASTE - PULSADOR DE PROGRAMACIÓN - PROGRAMMEERKNOP</p>
		<p>LED DI SEGNALE ON-OFF SENSORE SOLE - SUN SENSOR ON/OFF LED INDICATOR - LED DE SIGNALISATION ON-OFF CAPTEUR SOLAIRE - ANZEIGE-LED ON-OFF SONNENSSENSOR - LED DE SEÑALIZACIÓN ON-OFF SENSOR SOL - SIGNAAL-LED ZONSENSOR ON-OFF (*only XT6S 433)</p>
<p>SALITA - RISE - MONTÉE - AUF - SUBIDA - OMHOOG</p>	<p>SELEZIONE CANALE - CHANNEL SELECTION SELECTION CHAINE-CANAL SELECCION KANALWECHSEL - WYZIGING KANAAL</p>	
<p>ON/OFF SENSORE SOLE - ON/OFF SUN SENSOR - ON/OFF CAPTEUR SOLAIRE - ON/OFF SONNENSSENSOR - ON/OFF SENSOR SOL - ZONSENSOR ON/OFF (*only XT6S 433)</p>		<p>STOP/POSIZIONE PREFERITA - STOP/PREFERRED POSITION - STOP/POSITION PRÉFÉRÉE - STOPP/VORZUGSSTELLUNG - STOP/POSICIÓN PREFERIDA - STOP/VOORKEURSPOSITIE</p>
		<p>DISCESA - DESCENT - DESCENTE - AB - BAJADA - OMLAAG</p>

1 MEMORIZZAZIONE DEL PRIMO TELECOMANDO - MEMORY STORAGE OF THE FIRST REMOTE-CONTROL - MÉMORISATION DE LA PREMIÈRE TÉLÉCOMMANDE - SPEICHERUNG DER ERSTEN FERNBEDIENUNG - MEMORIZACIÓN DEL PRIMER TELEMANDO - GEHEUGENOPSLAG VAN DE EERSTE AFSTANDBEDIENING - GEHEUGENOPSLAG VAN DE EERSTE AFSTANDBEDIENING

- I -ATTENZIONE: Durante la fase di memorizzazione del primo telecomando e fino alla fine della procedura di SET-UP, il motore viene movimentato a uomo presente (PULSANTE MANTENUTO)
- GB - ATTENTION: During the memory storage of the first remote control until the end of the SET-UP procedure, the motor is activated by the operator (PUSH BUTTON PRESSED)
- F -ATTENTION : pendant la phase de mémorisation de la première télécommande et jusqu'à la fin de la procédure de SET-UP, le moteur est mis en mouvement par une présence humaine (POUSSOIR MAINTENU ENFONCÉ)
- D - ACHTUNG: Während der Speicherung der ersten Fernbedienung kann der Motor bis zur Beendigung des SET-UPs nur von Hand betrieben werden (PERMANENTER TASTENDRUCK)
- E -ATENCIÓN: Durante la fase de memorización del primer telemando y hasta la fase del procedimiento de SETUP, el operador activa el motor (PULSADOR MANTENIDO)
- NL -LET OP: Tijdens de geheugenopslag van de eerste afstandsbediening tot en met het einde van de SET-UP-procedure wordt de motor aangedreven met dead man (KNOP INGEDRUKT)

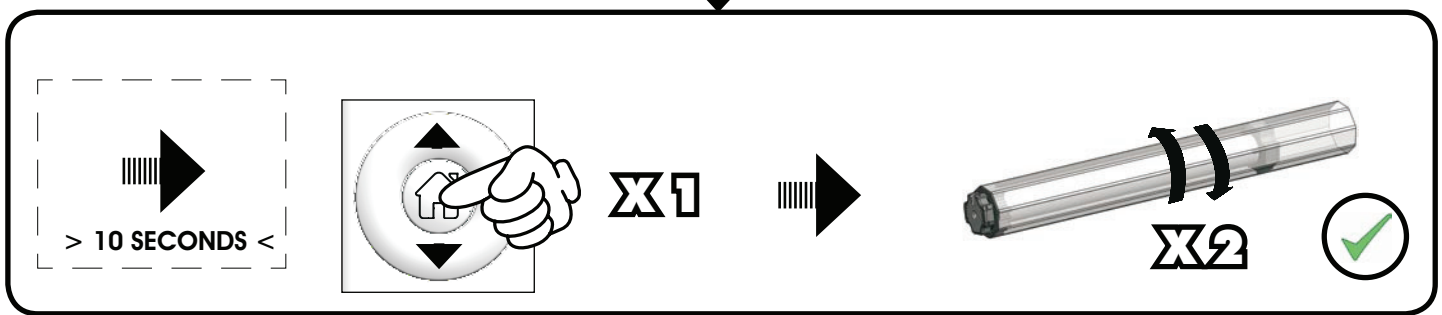
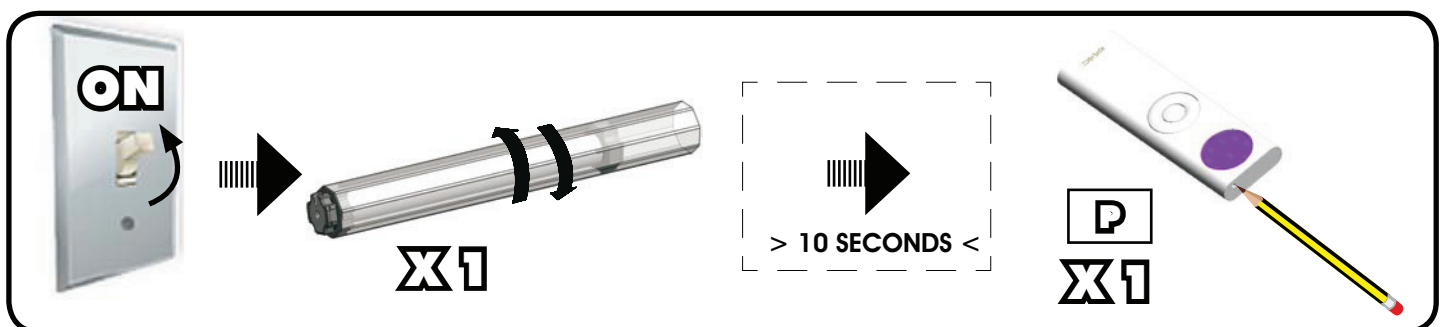

T MODE

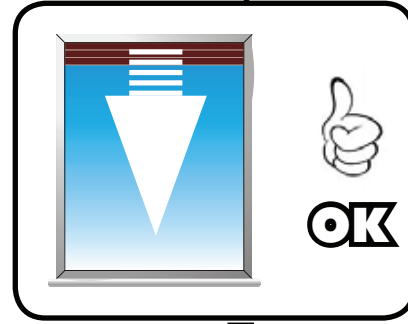
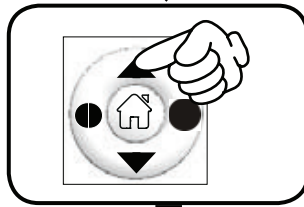

SET-UP

ESEGUIRE IL SET-UP - START SET-UP - COMMENCER LE SET-UP
- SCHRITTE Der SETUP - INICIO EL SET-UP - Begonnen met de SET-UP

**2 AGGIUNTA DI ALTRI TELECOMANDI - ADDITION OF OTHER REMOTE CONTROLS -
- AJOUT DE TÉLÉCOMMANDES - ZUSÄTZLICHE FERNBEDIENUNGEN -
- AÑADIDO DE OTROS TELEMANDOS - TOEVOEGEN VAN ANDERE AFSTANDSBEDIENINGEN**

I - SCEGLIERE UN TELECOMANDO GIA' MEMORIZZATO, PREMERE IL TASTO "P" E SUCCESSIVAMENTE  (STOP)

GB - TAKE A PREVIOUSLY STORED REMOTE CONTROL, PRESS THE "P" SWITCH AND THEN PRESS  (STOP)

FR - CHOISIR UNE TÉLÉCOMMANDE DÉJÀ MÉMORISÉE, APPUYER SUR LA TOUCHE "P", PUIS SUR  (STOP)

D - EINE BEREITS GESPEICHERTE FERNBEDIENUNG NEHMEN, DIE TASTE "P" UND DANACH DIE TASTE  (STOPP) DRÜCKEN.

E - SELECCIONE UN TELEMANDO YA MEMORIZADO, PULSE EL PULSADOR "P" Y, A CONTINUACIÓN,  (STOP)

NL - SELECTEER EEN REEDS OPGESLAGEN AFSTANDSBEDIENING DOOR OP DE KNOP "P" TE DRUKKEN EN DAARNA OP  (STOP)

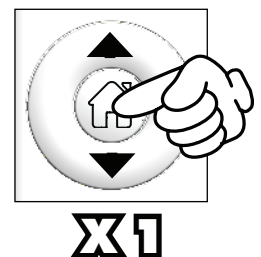
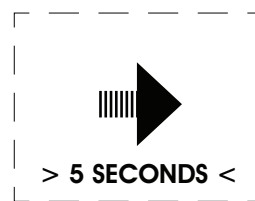
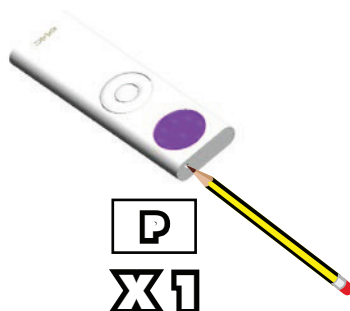

T MODE

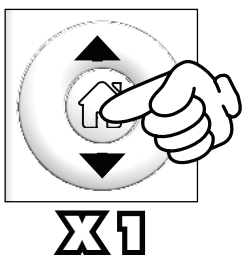
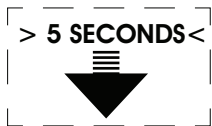

I - ENTRO 5 SECONDI PREMERE , IL TASTO  (STOP) SUL NUOVO TELECOMANDO DA MEMORIZZARE

GB- BEFORE 5 SECONS , PRESS THE  (STOP) PUSH-BUTTON ON THE NEW REMOTE CONTROL TO BE STORED

F - PENDANT 5 SECONDS, APPUYEZ SUR LA TOUCHE  (STOP) DE LA NOUVELLE TÉLÉCOMMANDE À MÉMORISER

D - INNERHALB VON 5 SEKUNDEN, AUF DER NEUEN ZU SPEICHERNDEN FERNBEDIENUNG DIE STOPP-TASTE  DRÜCKEN

E - EN 5 SEGUNDOS, PULSE EL PULSADOR DE  (STOP) EN EL NUEVO TELEMANDO A MEMORIZAR

NL - BINNEN 5 SECONDEN, DRUK OP DE STOP-TOETS  OP DE NIEUWE AFSTANDSBEDIENING DIE WORDT OPGESLAGEN

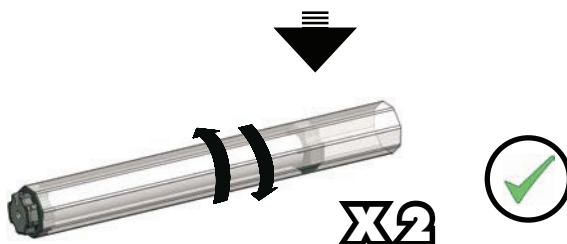

3 CANCELLAZIONE DI UN SINGOLO TELECOMANDO - CANCELLATION OF A SINGLE REMOTE CONTROL - EFFACEMENT D'UNE SEULE TÉLÉCOMMANDE - LÖSCHEN EINER FERNBEDIENUNG - ELIMINACIÓN DE UN SOLO TELEMANDO - ÉÉN AFSTANDSBEDIENING WISSEN

I - SCEGLIERE IL TELECOMANDO DA CANCELLARE DALLA MEMORIA

GB - CHOOSE THE REMOTE CONTROL TO BE CANCELLED FROM THE MEMORY

F - SÉLECTIONNEZ LA TÉLÉCOMMANDE À EFFACER DE LA MÉMOIRE

D - DIE AUS DEM SPEICHER ZU LÖSCHENDE FERNBEDIENUNG WÄHLEN

E - SELECCIONAR EL TELEMANDO A ELIMINAR DE LA MEMORIA

NL - SELECTEER DE AFSTANDSBEDIENING DIE UIT HET GEHEUGEN MOET WORDEN GEWIST

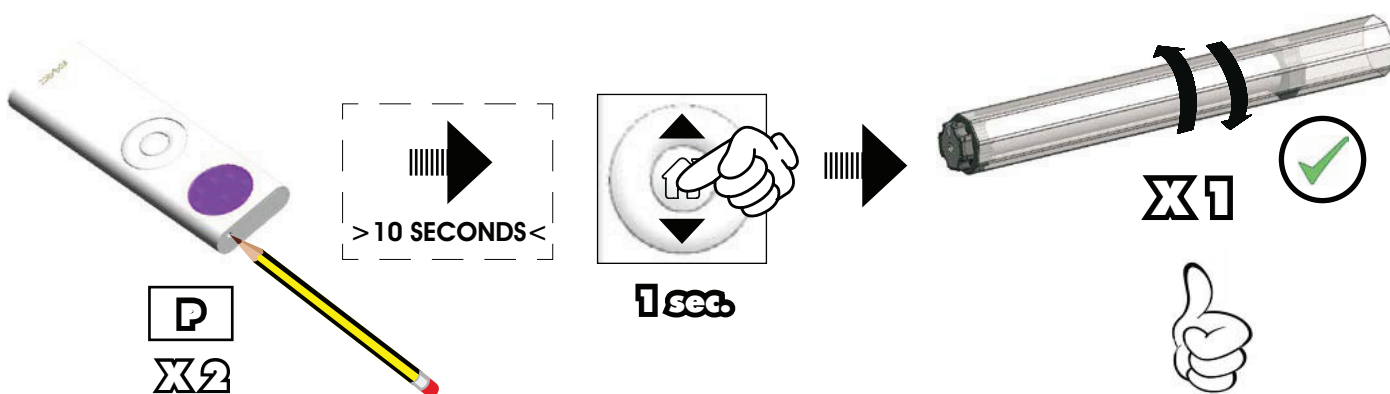

4 CANCELLAZIONE DI TUTTI I TELECOMANDI - CANCELLATION OF ALL THE REMOTE CONTROLS - EFFACEMENT DE TOUTES LES TÉLÉCOMMANDES - LÖSCHEN ALLER FERNBEDIENUNGEN - ELIMINACIÓN DE TODOS LOS TELEMANDOS - ALLE AFSTANDSBEDIENINGEN WISSEN

①	②
NERO	MARRONE
BLACK	BROWN
NOIR	MARRON
SCHWARZ	BRAUN
NEGRO	MARRÓN
ZWART	BRUIN

OFF

230 V ~

PUSH

I - Togliere l'alimentazione al motore e collegare il filo nero con il filo marrone. (Nel caso si abbia un pulsante "passo passo", basta tenerlo premuto senza effettuare il collegamento.) - **GB -** Cut power to the motor and connect the black wire to the brown wire. (If you have the step-by-step push-button, just hold it down without making any connection.) - **F -** Mettre le moteur hors tension. Connecter le fil noir au fil marron. (En présence d'un bouton-poussoir "pas à pas", il suffit de le maintenir enfoncé sans réaliser la connexion.) - **D -** Die Stromzufuhr zum Motor unterbrechen. Den schwarzen Draht mit dem braunen Draht verbinden. (Bei Taste mit Schrittbetriebsteuerung – diese einfach drücken, ohne die Verbindung herzustellen) - **E -** Retire la alimentación al motor. Conecte el hilo negro con el hilo marrón. (Si se dispone de un pulsador "paso-paso", basta mantenerlo pulsado sin efectuar la conexión.) - **NL -** Schakel de voeding naar de motor uit. Verbind de zwarte draad met de bruine draad. (Als er een "stap-voor-stap" drukknop is, is het voldoende deze in te drukken zonder de verbinding te maken.)

ON

X1

✔

I - Alimentare il motore dopo circa 5 secondi, il motore si muove in entrambe le direzioni per 1 secondo segnalando che la memoria è stata completamente cancellata. - **GB -** After 5 seconds, the motor moves in both directions for 1 second, signalling that the memory was completely deleted. - **F -** Mettre le moteur sous tension. Au bout de 5 secondes environ, le moteur tourne dans les deux directions pendant 1 seconde, pour signaler que la mémoire a été complètement effacée. - **D -** Den Motor mit Strom versorgen. Nach etwa 5 Sekunden läuft der Motor 1 Sekunde lang in beide Richtungen. Dadurch wird signalisiert, dass der Speicher vollständig gelöscht wurde. - **E -** Suministre alimentación al motor. Transcurridos unos 5 segundos, el motor se mueve en ambas direcciones durante 1 segundo para indicar que la memoria se ha borrado completamente. - **NL -** Schakel de voeding van de motor in. Na ongeveer 5 seconden beweegt de motor 1 seconde in beide richtingen, om aan te geven dat het geheugen helemaal gewist is.

T MODE

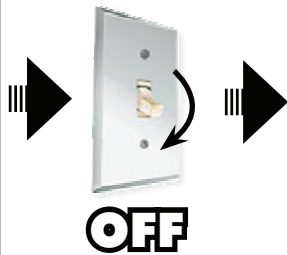

①	②
NERO	MARRONE
BLACK	BROWN
NOIR	MARRON
SCHWARZ	BRAUN
NEGRO	MARRÓN
ZWART	BRUIN

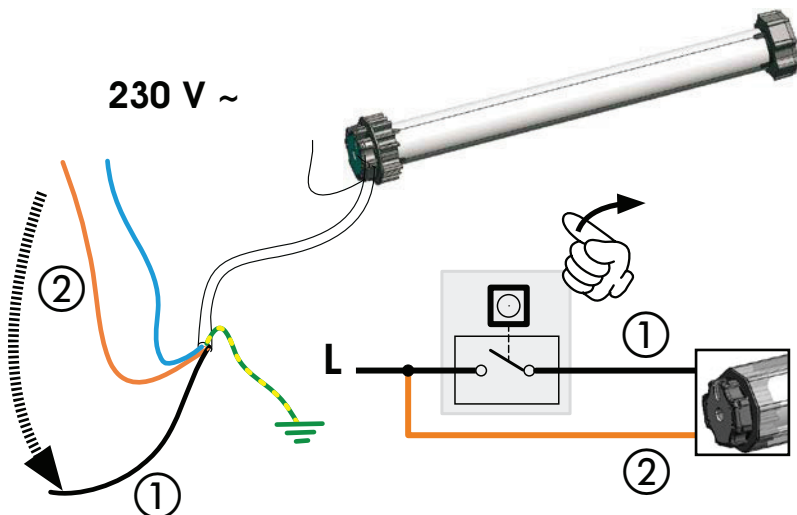

I - Togliere nuovamente l'alimentazione al motore. Scollegare il filo nero e marro-ne. (Rilasciare il pulsante nel caso si abbia il pulsante "passo-passo".) - GB - Cut power to the motor again. Disconnect the black and brown wire. (Release the push-button if you have the step-by-step push-button.) - F - Mettre de nou-veau le moteur hors tension. Déconnecter les fils noir et marron. (Relâcher le bouton-poussoir en présence du bouton-poussoir "pas à pas".) - D - Die Stromzufuhr zum Motor erneut unterbrechen. Den schwarzen und den braunen Draht abklemmen. (Bei Taste mit Schritt-betriebsteuerung die Taste loslassen.) - E - Vuelva a retirar la alimentación al motor. Desconecte el hilo negro y marrón. (Suelte el pulsador si se dispone del pulsador "paso-paso".) - NL - Schakel de voeding naar de motor opnieuw uit. Maak de zwarte en bruine draad los. (Laat de drukknop los, in het geval de "stap-voor-stap" drukknop wordt gebruikt.)



OK

5 MEMORIZZAZIONE POSIZIONE PREFERITA - STORAGE OF THE PREFERRED POSITION - MÉMORISATION POSITION PRÉFÉRÉE - SPEICHERUNG DER VORZUGSSTELLUNG - MEMORIZACIÓN POSICIÓN PREFERIDA - GEHEUGENOPSLAG VOORKEURSPOSITIE

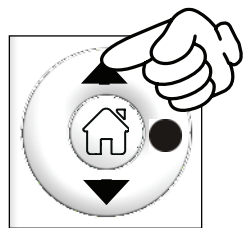

1 sec.

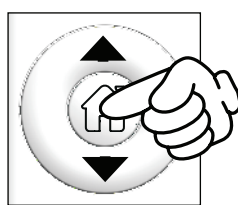
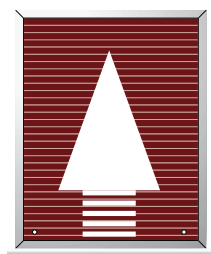

1 sec.

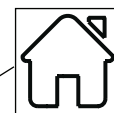
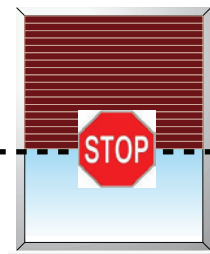

PREFERRED POSITION

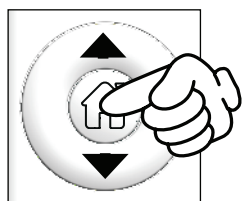

5 sec.



X1



OK

5.1 COME USARE IL TASTO POSIZIONE PREFERITA - HOW TO USE PREFERRED POSITION BUTTON - COMME UTILISÉ LE BOUTON POSITION PRÉFÉRÉE - COME USARE IL TASTO VORZUGSSTELLUNG - CÓMO USAR EL BOTÓN POSICIÓN PREFERIDA - GEBRUIK DE KNOP VOORKEURSPOSITIE

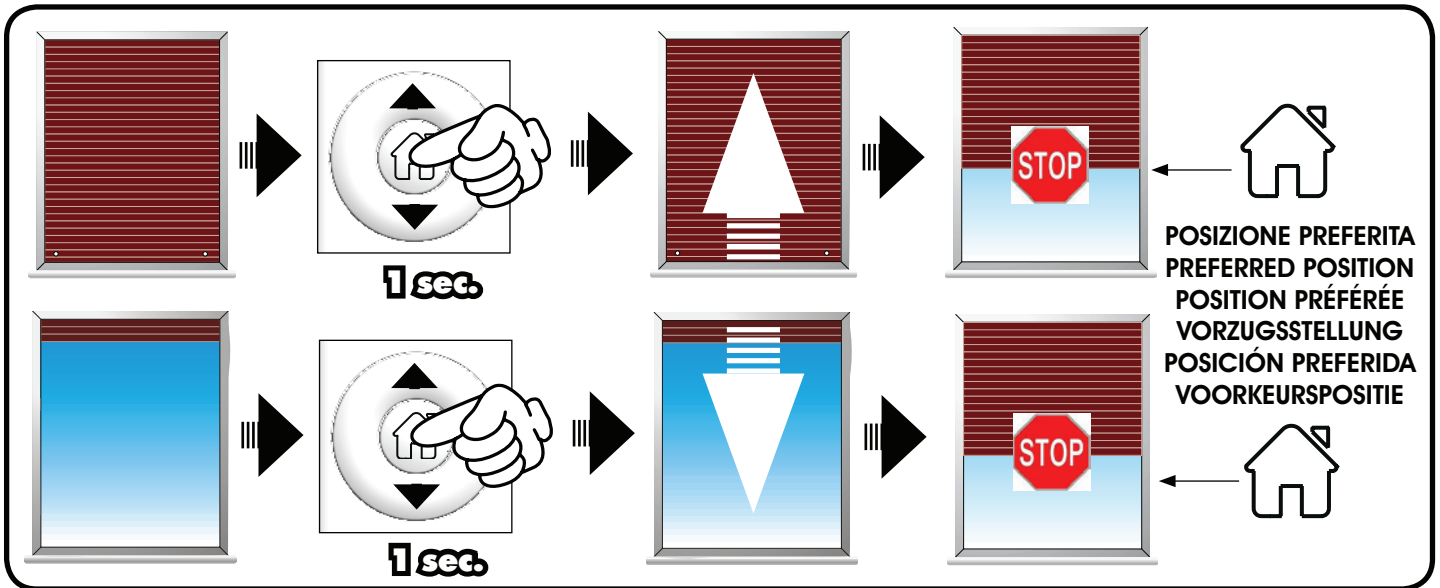

6 ON-OFF SENSORE SOLE - ON-OFF SUN SENSOR - ON-OFF CAPTEUR SOLAIRE - ON-OFF SON-SENSORE - ON-OFF SENSOR SOL - ZONSENSOR ON-OFF (*only XT6S 433)

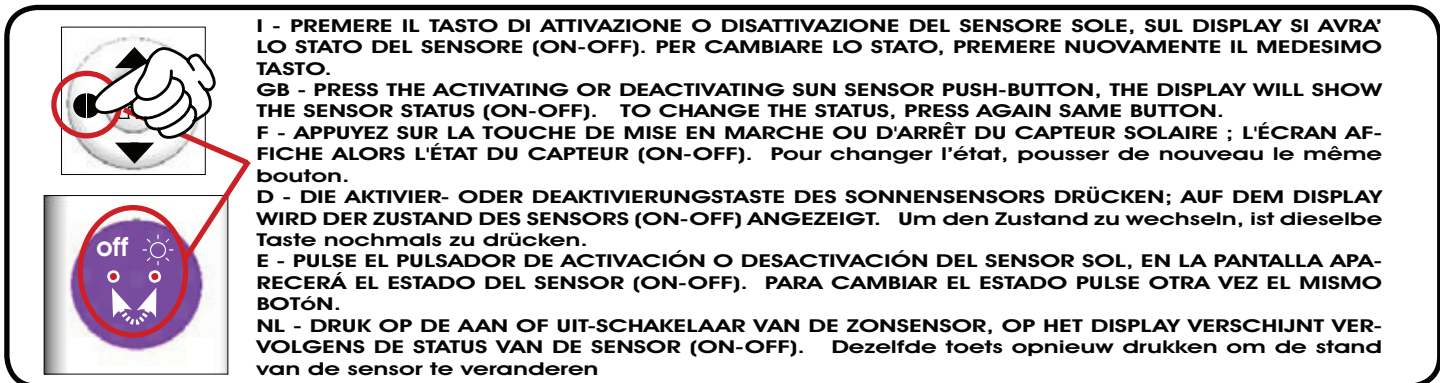

7 SELEZIONE CANALE - CHANEL SELECTION - SELECTION CHAINE - SELECCION CANAL - KANAL-WECHESSEL - WYZIGING KANAAL

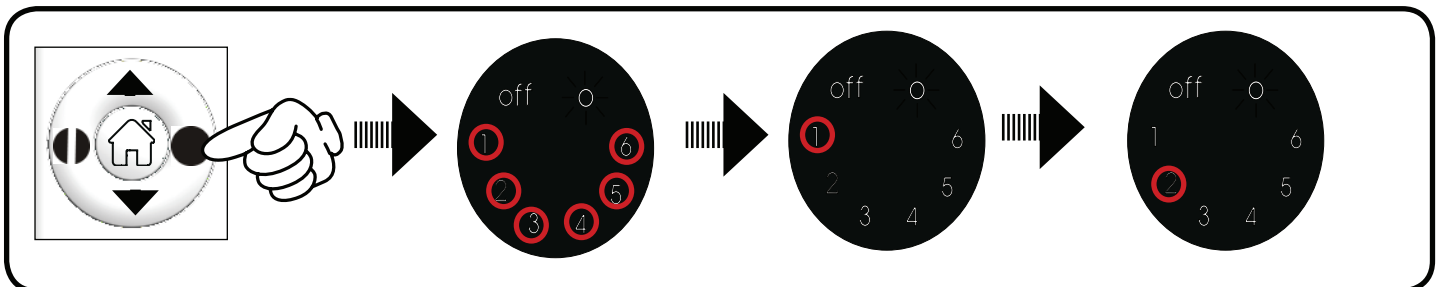

8 SOSTITUZIONE DELLA PILA - BATTERY SUBSTITUTION - REMPLACEMENT DE LA PILE - AUSWECHSELN DER BATTERIE - SUSTITUCIÓN DE LA BATERÍA - DE BATTERIJ VERVANGEN

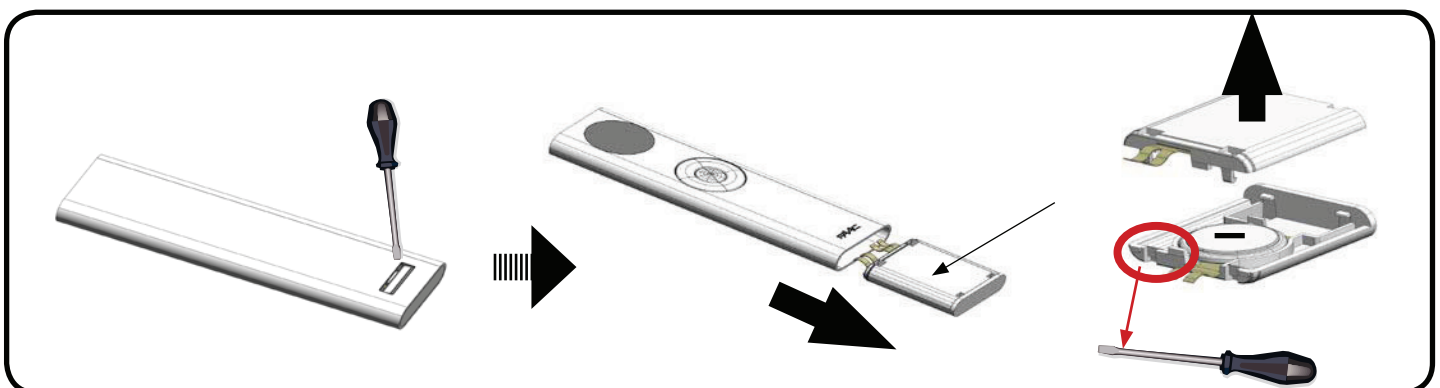

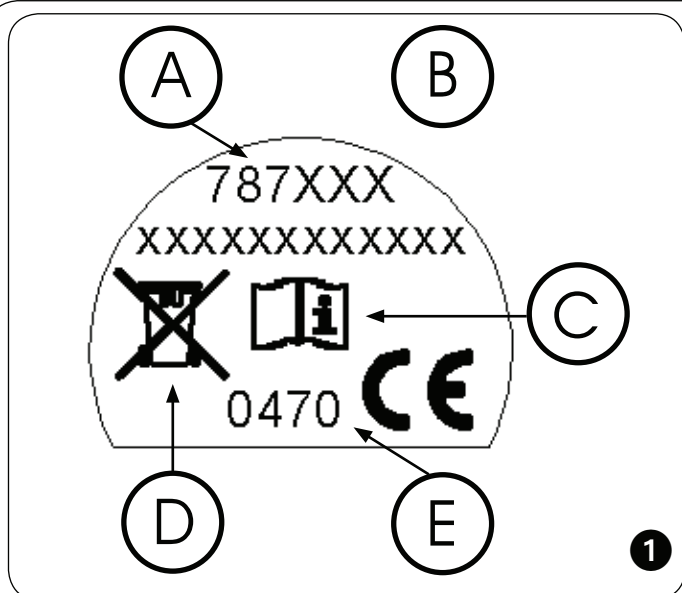

DESCRIZIONE ETICHETTA (Figura 1)

- A - Codice identificativo del modello
- B - Numero identificativo del lotto di produzione
- C - Leggere le istruzioni
- D - Smaltire secondo le direttive vigenti
- E - Riferimento notified body

Frekuensi di lavoro	433,92 MHz ± 100 KHz
Tipo batteria	3 V CR2340 Litio
Uso esclusivo	Apricancello
Questo prodotto è conforme alla direttiva 99/05/CEE	

DESCRIPTION OF THE LABEL (Fig. 1)

- A - Model identification code
- B - Identification number of the production batch
- C - Read the instructions
- D - Observe the current regulations for a correct disposal
- E - Notified body reference

Work frequency	433.92 MHz ± 100 KHz
Battery type	3 V CR2340 Litio
Intended use	Gate opener
This product conforms to directive 99/05/EEC	

DESCRIPTION ÉTIQUETTE (Figure 1)

- A - Code d'identification du modèle
- B - Numéro d'identification du lot de production
- C - Lire les instructions

D - Éliminer selon les directives en vigueur

E - Référence organisme notifié (notified body)

Fréquence de fonctionnement	433,92 MHz ± 100 KHz
Type batterie	3 V CR2340 Litio
Usage exclusif	Ouvre-portail
Ce produit est conforme à la directive 99/05/CEE	

BESCHREIBUNG DES ETIKETTS (Abb. 1)

- A - Kennnummer des Modells
- B - Kennnummer des Produktionsloses
- C - Die Anweisungen lesen
- D - Gemäß den geltenden gesetzlichen Vorschriften entsorgen
- E - Bezugsinformationen benannte Stelle (notified body)

Betriebsfrequenz	433,92 MHz ± 100 KHz
Batterietyp	3 V CR2340 Litio
Bestimmungsgemäßer Gebrauch	Toröffnung
Dieses Produkt entspricht der Richtlinie 99/05/EWG	

DESCRIPCIÓN DE LA ETIQUETA (Figura 1)

- A - Código de identificación del modelo
- B - Número de identificación del lote de producción
- C - Leer las instrucciones
- D - Eliminar según las directivas vigentes
- E - Referencia organismo notificado (notified body)

Frecuencia de trabajo	433,92 MHz ± 100 KHz
Tipo de batería	3 V CR2340 Litio
Uso exclusivo	Abrecancela
Este producto es conforme con la directiva 99/05 CEE	

BESCHRIJVING ETIKET (Figuur 1)

- A - Identificatiecode van het model
- B - Identificatienummer van de productiepartij
- C - Lees de instructies
- D - Verwijder het afgedankte product volgens de geldende richtlijnen
- E - Referentie aangemelde instantie (notified body)

Gebruiksfrequentie	433,92 MHz ± 100 KHz
Type batterij	3 V CR2340 Litio
Exclusief gebruik	Poortopener
Dit product is in overeenstemming met de richtlijn 99/05/EEG	



FAAC S.p.A.
Via Benini, 1
40069 Zola Predosa (BO) - ITALIA - Tel. 0039.051.61724 -
www.faacgroup.com

