

Instructions and warnings for the fitter
 Istruzioni ed avvertenze per l'installatore
 Instructions et recommandations pour l'installateur
 Instrucciones y advertencias para el instalador
 Anweisungen und Hinweise für den installateur
 Instrukcje i ostrzeżenia dla instalatora
 Aanwijzingen en aanbevelingen bestemd voor de installateur

TW1

Thermostat for heating unit

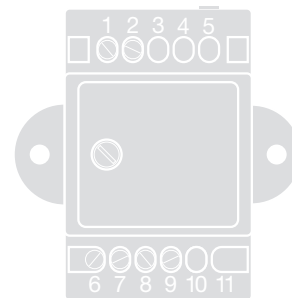

COMPANY
 WITH QUALITY SYSTEM
 CERTIFIED BY DNV
 =ISO 9001/2000=

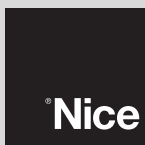

INSTALLATION

Product for all the ROBO, THOR, ROBUS, WIL and SIGNO models.

To install to the inside of the automatism

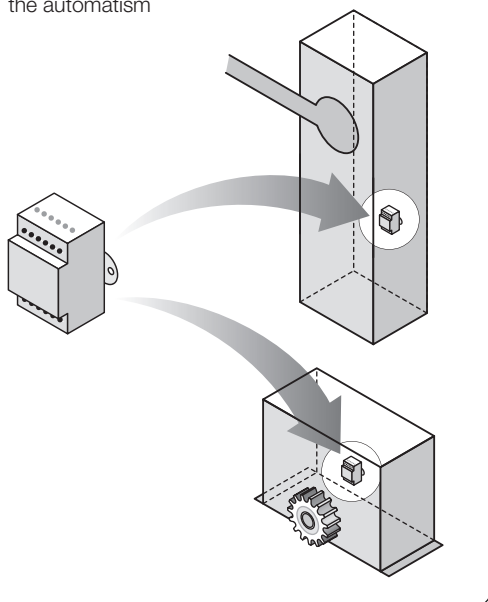

DISPOSAL



TECHNICAL CHARACTERISTICS

- Rated voltage: 230V; 50Hz / 120V; 60Hz
- Maximum motor output power: 200W
- Absorbed power: < 1,2W
- Range of regulation of the temperature: $-20 \div 0^{\circ}\text{C}$ (+10 \div +30 $^{\circ}\text{C}$ with the key "Test" pressed)
- Protection class: IP 10
- Dimensions (L, P, H, mm): 58 x 37 x 59 (with flaps); 38 x 37 x 59 (without flaps)

NOTES: • All the technical characteristics refer to a room temperature of 20 $^{\circ}\text{C}$ (\pm 5 $^{\circ}\text{C}$). • Nice S.p.a. reserves the right to modify their products any time they deem necessary, guaranteeing their functionality and fitness for the intended purposes.

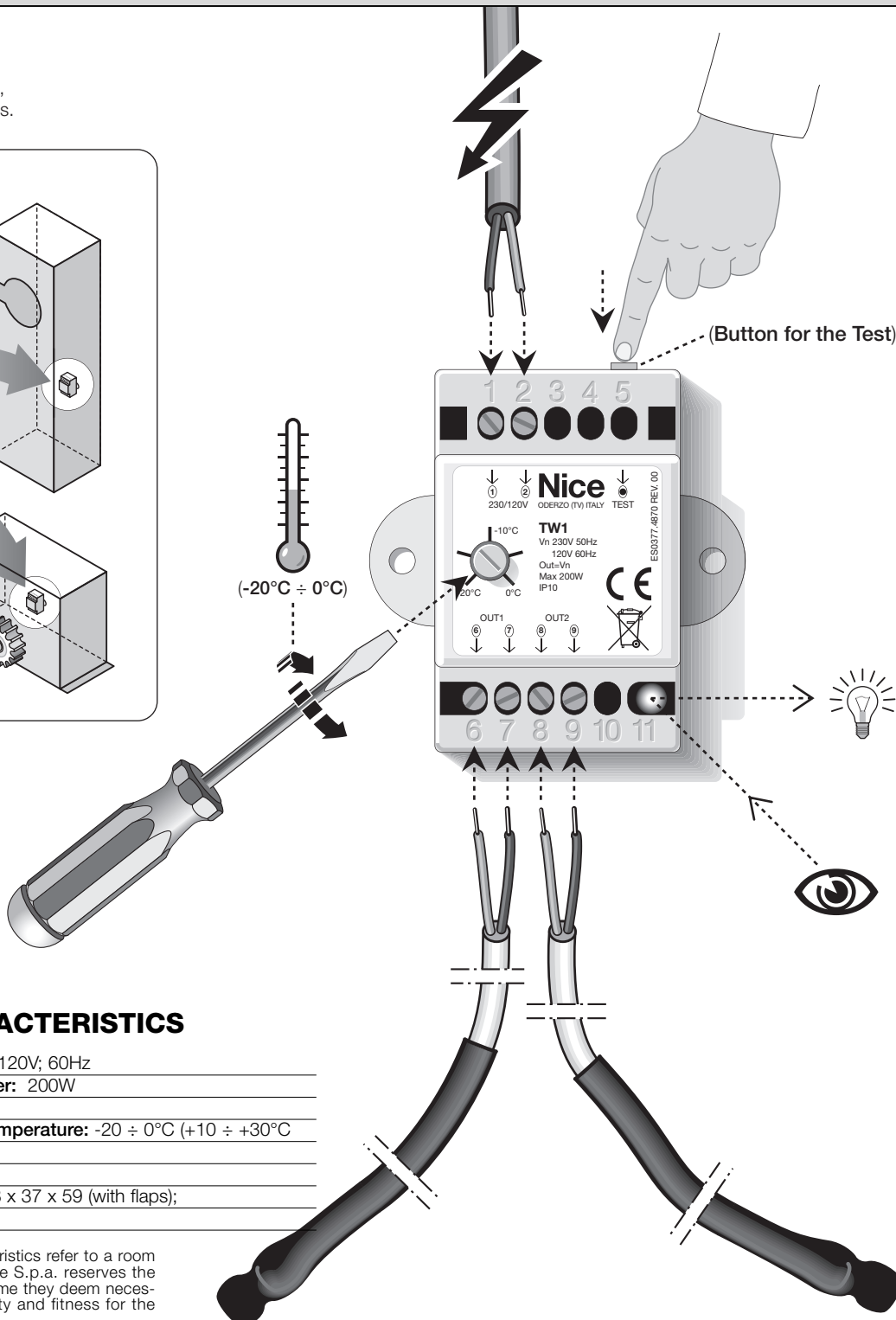

TEST OF OPERATION

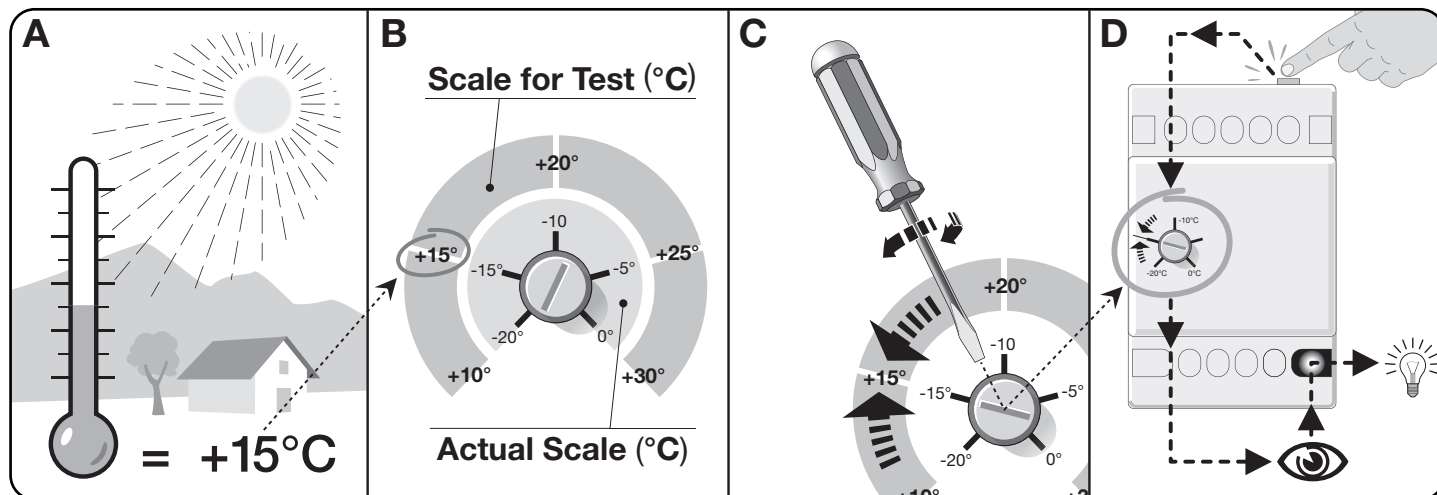

DICHIARAZIONE CE DI CONFORMITÀ DECLARATION OF CONFORMITY

NOTE: • Il contenuto di questa dichiarazione corrisponde a quello dell'ultima revisione disponibile, - prima della stampa del presente manuale, - del documento ufficiale depositato presso la sede di Nice S.p.a. In questo manuale, il testo originale è stato riadattato per motivi editoriali. • La presente dichiarazione è valida solo per i modelli citati.

NOTES: • The content of the present declaration corresponds to the latest available revision, - before the printing of the present manual, - of the document registered at the head offices of Nice S.p.a. The original text of this manual has been readapted for publishing reasons. • The present declaration is valid for the said models only.

Numero: **237/TW1**; Revisione: **0**
Number: **237/TW1**; Revision: **0**

Il sottoscritto Lauro Buoro in qualità di Amministratore Delegato, dichiara sotto la propria responsabilità che il prodotto:
The undersigned Lauro Buoro, managing director, declares under his sole responsibility that the following product:

Nome produttore: **NICE s.p.a.**
Manufacturer's name: **NICE s.p.a.**

Indirizzo: **Via Pezza Alta 13, Z.I. Rustignè, 31046 Oderzo (TV) Italia**
Address: **Via Pezza Alta 13, Z.I. Rustignè, 31046 Oderzo (TV) Italy**

Tipo: **Termostato per unità riscaldanti TW1; abbinato a unità riscaldanti PW1**
Type: **Thermostat for heating unit TW1; join at heating unit PW1**

Modello: **TW1** - Accessori: **PW1**
Models: **TW1** - Accessories: **PW1**

Risulta conforme a quanto previsto dalle seguenti direttive comunitarie, così come modificate dalla Direttiva 93/68/CEE del consiglio del 22 Luglio 1993:
Satisfies the essential requirements of the following Directives, as amended by the directive 93/68/EEC of the European Council of 22 July 1993:

- 89/336/CEE DIRETTIVA 89/336/CEE DEL CONSIGLIO del 3 maggio 1989, per il riavvicinamento delle legislazioni degli Stati membri relative alla compatibilità elettromagnetica.
- 89/336/EEC DIRECTIVE 89/336/EEC OF THE COUNCIL of May 3, 1989, for the harmonisation of the legislations of member States regarding electromagnetic compatibility.

According to the following norms harmonized: EN 61000-6-2; EN 61000-6-3

- 73/23/CEE DIRETTIVA 73/23/CEE DEL CONSIGLIO del 19 febbraio 1973 concernente il riavvicinamento delle legislazioni degli Stati membri relative al materiale elettrico destinato ad essere adoperato entro taluni limiti di tensione.
- 73/23/EEC DIRECTIVE 73/23/EEC OF THE COUNCIL of February 19, 1973 for the harmonisation of the legislations of member States regarding electrical equipment designed to be used within certain voltage limits.

According to the following harmonized norm: EN 60335-1

Oderzo, 25 Novembre 2005
Oderzo, 25th November 2005

Lauro Buoro
(Amministratore delegato)
(Managing director)



Headquarter

 **Nice SpA**
Oderzo TV Italia
Tel. +39.0422.85.38.38
Fax +39.0422.85.35.85
info@niceforyou.com

Nice in Italy

 **Nice Padova**
Sarmeola di Rubano PD Italia
Tel. +39.049.89.78.93.2
Fax +39.049.89.73.85.2
infopd@niceforyou.com

 **Nice Roma**
Roma Italia
Tel. +39.06.72.67.17.61
Fax +39.06.72.67.55.20
inforoma@niceforyou.com

Nice in the World

 **Nice France**
Buchelay
Tel. +33.(0)1.30.33.95.95
Fax +33.(0)1.30.33.95.96
info@fr.niceforyou.com

 **Nice Rhône-Alpes**
Decines Charpieu France
Tel. +33.(0)4.78.26.56.53
Fax +33.(0)4.78.26.57.53
infolyon@fr.niceforyou.com

 **Nice France Sud**
Aubagne France
Tel. +33.(0)4.42.62.42.52
Fax +33.(0)4.42.62.42.50
infomarseille@fr.niceforyou.com

 **Nice España Madrid**
Tel. +34.9.16.16.33.00
Fax +34.9.16.16.30.10
info@es.niceforyou.com

 **Nice España Barcelona**
Tel. +34.9.35.88.34.32
Fax +34.9.35.88.42.49
info@es.niceforyou.com

 **Nice Polska**
Pruszków
Tel. +48.22.728.33.22
Fax +48.22.728.25.10
info@pl.niceforyou.com

 **Nice Belgium**
Leuven (Heverlee)
Tel. +32.(0)16.38.69.00
Fax +32.(0)16.38.69.01
info@be.niceforyou.com



 **Nice UK**
Chesterfield
Tel. +44.87.07.55.30.10
Fax +44.87.07.55.30.11
info@uk.niceforyou.com

 **Nice Romania**
Cluj Napoca
Tel/Fax +40.264.45.31.27
info@ro.niceforyou.com

 **Nice Deutschland**
Gelnhausen-Hailer
Tel. +49.60.51.91.52-0
Fax +49.60.51.91.52-119
info@de.niceforyou.com

 **Nice China**
Shanghai
Tel. +86.21.575.701.46
+86.21.575.701.45
Fax +86.21.575.701.44
info@cn.niceforyou.com

COMPANY
WITH QUALITY SYSTEM
CERTIFIED BY DNV
=ISO 9001/2000=

 **Nice Gate** is the doors and gate automation division of Nice
 **Nice Screen** is the rolling shutters and awnings automation division of Nice

www.niceforyou.com